

ONSIGHT-VUZIX

TELEHEALTH KIT

This document contains instructions for using Onsight Connect on a Vuzix Device.

Step 1: The Vuzix battery should be fully or adequately charged prior to an Onsight call using the provided USB cable. Charge time can be up to 2 hours.

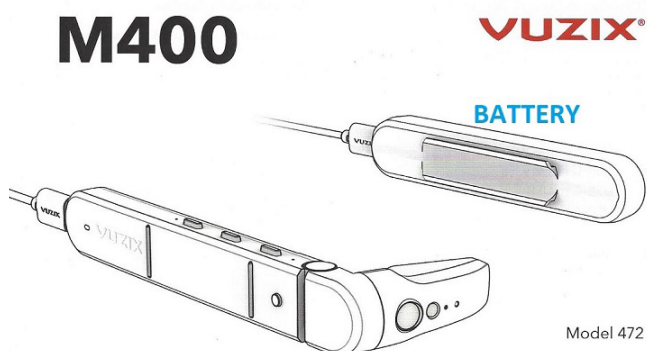

Step 2: Determine your dominate eye. Create a triangle using your thumbs and forefingers as shown. With both eyes open, look through the triangle and center something such as a doorknob in the triangle. Close your left eye. If the object remains in view, you are right-eye dominant. If closing your right eye keeps the object in view, you are left eye dominant. **You should be at least 3 feet away from the object when performing this test.**



Step 3: Connect the Viewer and Battery using the provided USB cable, making certain the Viewer is on the side of your dominant eye. Connecting the two will automatically boot the device then display the **HOME** screen.

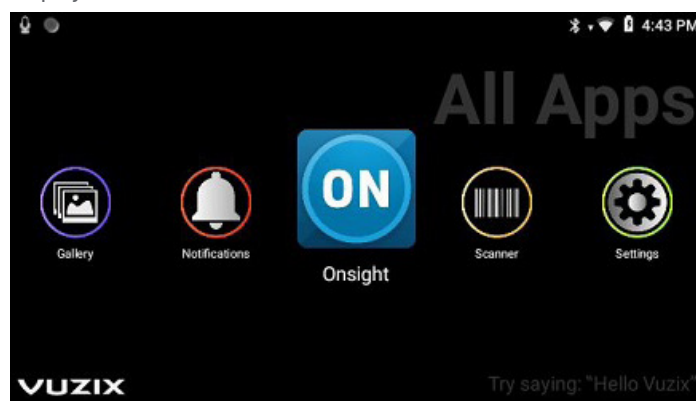

Step 4: Enable voice recognition. You must enable voice recognition in order for the Vuzix device to execute recognizable voice commands. To enable voice recognition say **“HELLO VUZIX”**.

The Microphone icon located in the top left corner indicates when voice recognition is enabled and disabled. By default, voice recognition is turned off (i.e.. disabled) after **15 seconds** of voice inactivity, unless otherwise changed by your Administrator.

Note: It is important to say **“HELLO VUZIX”** after 15 seconds of inactivity to re-enable the voice recognizer.

Step 5: Wi-Fi Setup

Create a Quick Response (QR) Code securely using the QR Code generator found at the Vuzix website. Navigate to: <https://www.vuzix.com/wifiQR> using either your smartphone or PC. (Example below)

Vuzix Wi-Fi QR Code Generator

SSID

Encryption

WPA/WPA2

Password

Hidden Network

GENERATE

Enter your Wi-Fi information, then click **GENERATE**.

From the Vuzix **HOME** screen, to navigate say either “**MOVE RIGHT**” or “**MOVE LEFT**”. Position the **Scanner** app at the center and say, “**SELECT THIS**” or “**PICK THIS**”.

Place the barcode inside the viewfinder rectangle to scan it. You will have **30 seconds** to scan the barcode before having to click **GENERATE** again.

If necessary say “**HELLO VUZIX**” to re-enable voice recognition.



Note: Step 5 should only need done once.

Step 6: Launch On sight Connect.

From the **HOME** screen, navigate either right or left to position **On sight** at the center. Say either “**SELECT THIS**” or “**PICK THIS**”.

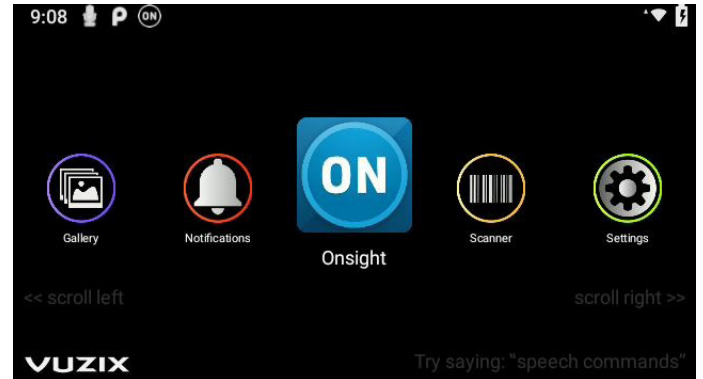

If you have setup a Quick Response (QR) code, say “**SCAN CODE**” and follow the instructions displayed onscreen. Once scanned, you will be automatically logged in to On sight Connect. Refer to the [On sight Vuzix User Guide](#) to setup a QR code login.

Note: If a custom message appears during login that prompts you to agree to terms and conditions, you must tap OK to indicate compliance in order to advance. If you are asked for permissions to access your microphone audio, camera pictures, device’s location etc., tap **OK, Allow** or **Yes**, as necessary.

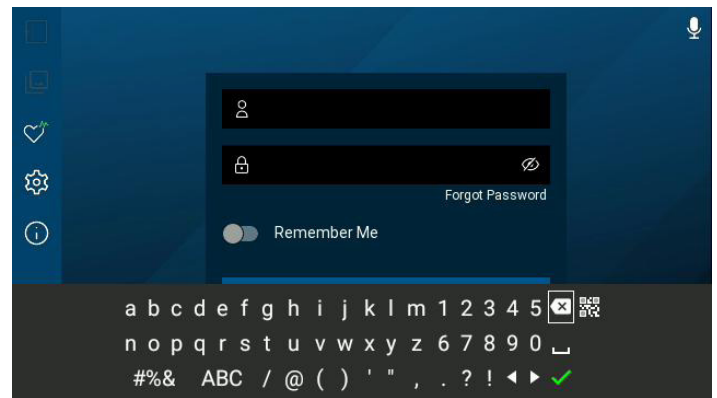

Step 7: Check System Health.

Once logged in, say “**SYSTEM HEALTH**” and confirm that the top four services are enabled **green**. If not, contact your On sight Administrator.

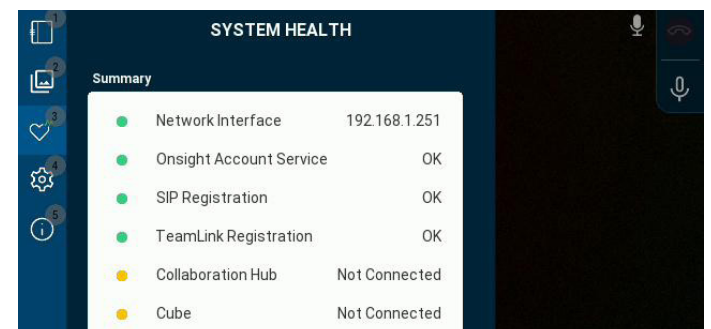

Step 8: Wait to Receive an Onsight Call.

You are now ready to receive an Onsight call. When you receive a call your Vuzix device will ring and prompt you to accept or decline the call. Say **“ACCEPT”** or **“DECLINE”**.

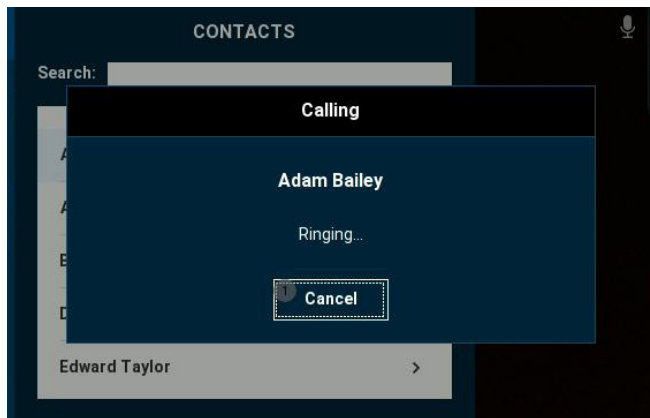

Step 9: Follow Instructions from Caller.

If you accepted the call, you are now in an Onsight call. The Caller or Expert will manage the call which can include the following:

- Take/Share picture(s)
- Start/Stop video streaming

TIP: When you are streaming video, the **Share Video**  icon appears as a status indicator next to the red **Hang Up** icon.

- Telestrate (i.e., annotate) on the screen. This can also be performed by you with assistance from the Expert.
- Bring in other Participants into the call

Note: There are two voice commands to locate available voice commands in the Onsight app: **“SHOW HELP”** and **“SHOW TOOLTIPS”**.

SHOW HELP

To execute the voice commands, simply say any of the voice commands as listed.



To remove the Help screen, say **“HIDE HELP”**.

SHOW TOOLTIPS

To execute the voice commands, simply say any of the voice commands as listed.

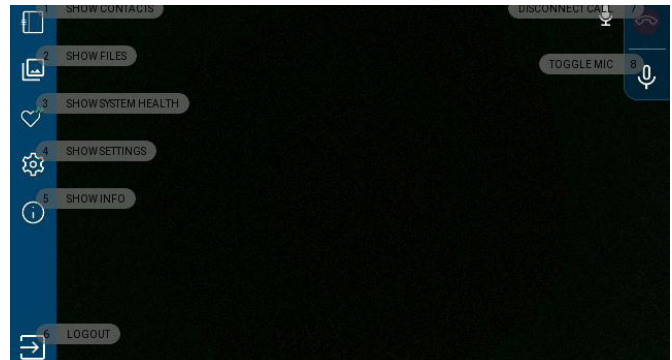

To remove the tooltips screen, say **“HIDE TOOLTIPS”**.

Step 10: Logout and Power Off

Once you have ended your Onsight call, logout by saying **“LOGOUT”**, then say **“YES”**.

Note: Remember to say **“HELLO VUZIX”** to re-enable the voice recognizer when needed.

POWER OFF the device by pressing and holding down the **Power Button** for a few seconds. Disconnect the USB cable to the Vuzix battery, then using your **Touch Pad** on the Vuzix device select **Power off**.

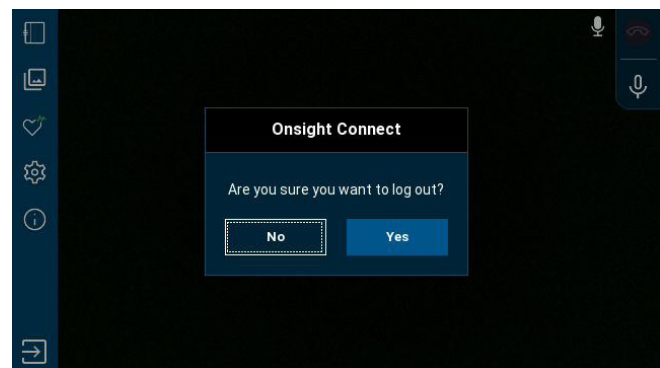

NOTES:

FOR SUPPORT:

<http://librestream.com/onsight-support/>

JUST-IN-TIME TRAINING MATERIALS:

<http://librestream.com/training-deployment-adoption-materials/>